

■ Dimensions

Unit:mm

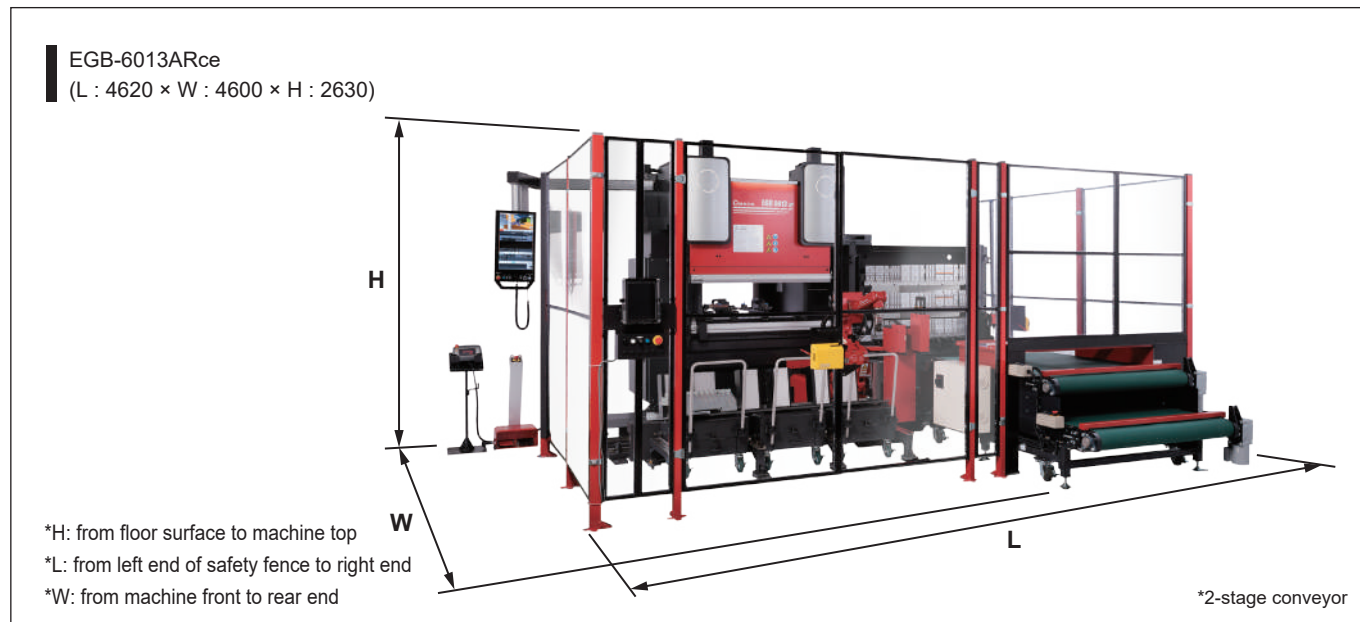

■ Machine Specifications

Model		EGB-6013ARce				
Model name		EGB6013RE				
Press Brake	Tonnage capacity	kN	600			
	Open height	mm	585			
	Stroke length	mm	150			
	Approach speed	mm/s	250			
	Max. bending speed	mm/s	9(without robot-follow)			
Model name		EGBRBT010E				
Axis composition		Robot : 6 axes Travel axis:1 axis				
Payload		kg	10 (with gripper)			
Robot	Travel axis		Stroke	m	3.2	
	No. of gripper		Max. No. of gripper (for bend)	set	7	
			No. of gripper (for tool)	set	1	
	Tool stocker		Max. no. of tool kinds to be installed		kind	27 (3 rows x 3 racks x 3 kinds)
			No. of loading position			3 (6 when separated)
	Loading unit		Workpiece stacking height		mm	300
	Unloading unit		Max weight on unloading conveyor		kg/m	60
	Max. workpiece size				mm	400 × 400 or 300 × 550
Min. workpiece size				mm	30 × 80	
Workpiece thickness				mm	0.5 - 0.6*	
Max. workpiece mass				kg	3.2	

\*Be sure to use an appropriate gripper when thick worksheet is used

\*Specifications, appearances and equipment are subject to change without notice by reason of improvement.  
\*Official model names of machine & device described in this catalog is EGB6013ARce  
EGB6013ARce is the name of system combining EGB6013RE and EGBRBT010E  
\*The hyphenated spellings EGB-6013ARce is used in some portion of this catalog for sake of readability.  
\*The specifications described in this catalog are for the Japanese domestic market

Be sure to read the manual carefully before use.  
• Use of this product requires safeguard measures to suit your work

© AMADA CO., LTD. All Rights Reserved.

**AMADA CO., LTD.**  
200, Ishida, Isehara-shi, Kanagawa, 259-1196, Japan  
www.amada.co.jp



E171-HQ01en  
Dec. 2023

Automatic Bending System for small-parts with Electric Servo Drive



# EGB 6013 ARc



Electric servo drive press brake  
designed for people and the environment.



**The Engineering AMADA**





## Smart operation

# Easy set up, Compact automation system

The EGB-6013ARce, now equipped with 4ie technology, is a user-friendly and eco-conscious solution for all users around the globe. The time required to launch new products has been significantly reduced by integrating sensing functions, allowing easy corrections without hassle. The portable tablet HMI displays essential product setup information and more, making it even more convenient to use.



Automatic Bending System for small-parts with Electric Servo Drive

## EGB 6013 ARc

### AMNC 4ie

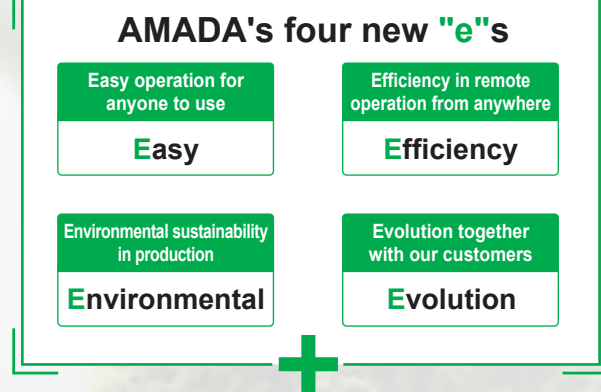

"4i" adds new elements to the conventional 3i

**Intelligent**  
**Interactive**  
**Integration**  
**Innovative**

## Processing samples



### Small precision part

Material : SECC  
Thickness : 1.0mm  
Size : 50 x 33 x 13mm  
No. of bend : 12 bends  
Processing time : 1 min. 33 sec.



### Machine cover part

Material : SECC  
Thickness : 1.0mm  
Size : 423 x 127 x 101mm  
No. of bend : 11 bends  
Processing time : 2 min. 27 sec.



### Part using vertical loading

Material : SECC  
Thickness : 1.0mm  
Size : 107 x 40 x 60mm  
No. of bend : 5 bends  
Processing time : 44 sec.



### Heavy gauge part

Material : SPHC  
Thickness : 4.5mm  
Size : 260 x 90 x 140mm  
No. of bend : 3 bends  
Processing time : 60 sec.







# EGB-6013ARce Solution

## Press brake

Model name : EGB6013RE



Tonnage capacity 600kN  
Open height 585mm  
Stroke 150mm

## New servo drive

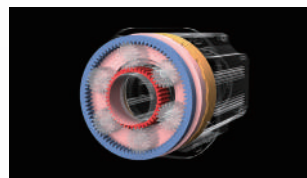

"Environmentally friendly" type of new servo drive has been adopted.

## Processing\* range

Unfold size  
30×80mm - 400×400mm, 300×550mm  
Thickness : 0.5 - 6.0mm

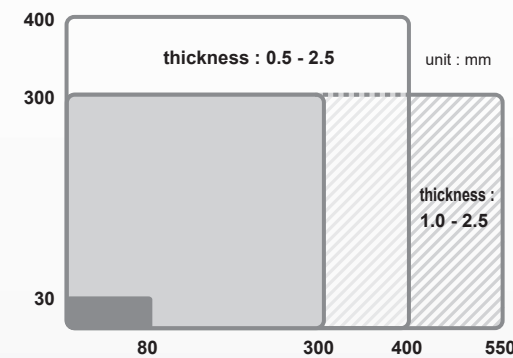

## Robot tablet HMI



Operability is improved by integrating information for CAM/AMNC 4ie into one tablet.

## AGC (Automatic Gripper Changer)

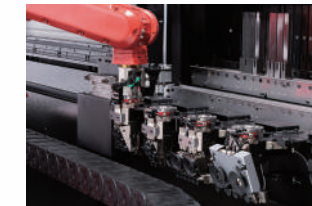

Grippers are changed automatically depending on the part.  
Max. 8 grippers.

## Robot (Articulated robot with 6 axes)

Model name : EGBRBT010E



Payload 10kg (with gripper)  
6-axes + 1 axis (traveling axis) articulated robot with a range of motion close to that of humans.

## L-shift back gauge + Side gauge

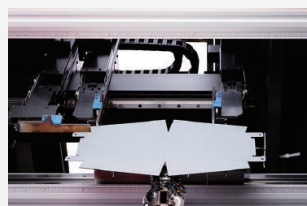

The back gauge system covers various blank shapes, providing stable gauging for parts with forming or slanted shapes.

## Mobile loading cart



The mobile loading cart designed for convenient off-line material setup achieves continuous operation.

## Thickness detector & active magnet floater



Prevents the picking up of two pieces by applying magnetic force when the robot lifts the material.

## Sensing function



Equipped with sensing technology to support start-up operations for new products.



\*If the blank mass exceeds the robot's payload capacity, processing may not be possible even if it falls within the specified range.





## Easy Easier for everyone

Option

### Automated correction

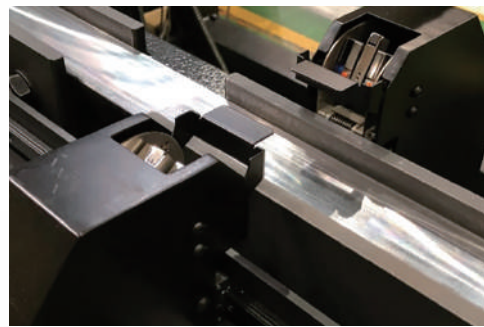

#### Contact-type automatic angle sensor Bi-SII

Applicable V-opening : V6 - V40  
 Applicable angles : 90 - 165°  
 Minimum flange : 16mm(V6) - 42mm(V40)  
 Auto 1 axis

### Setup Support



#### Z-direction sensing (height adjust sensor)

The laser displacement sensor automatically adjusts the height of the blank position when initiating a new product.

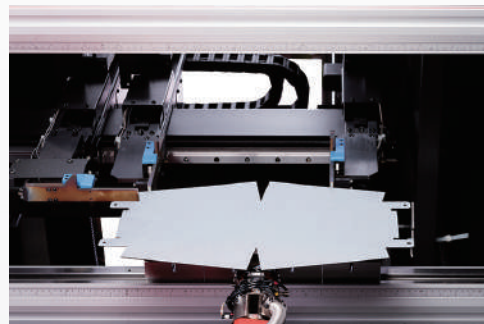

#### Side gauge & Back gauge sensors

Sensors in the side gauge and back gauge automatically correct the horizontal and vertical position of the blank. The gauging movement pattern is expanded, thereby broadening the range of applicable product shapes, including tapered bending.

### Programming

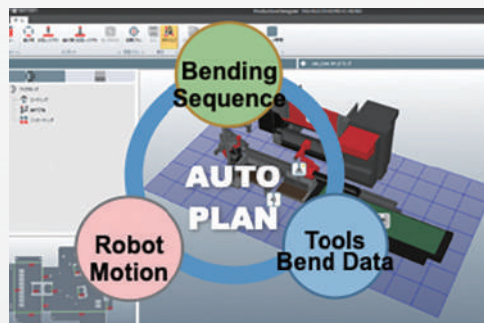

#### VPSS 4ie ARBEND (software)

Robot CAM software allows for offline programming without interrupting robot operation.



## Efficiency Can be used anywhere

Option

### Mobile loading cart



#### Continuous Operation

The independently movable carts enable the setup of blanks for the bending robot without the need for parts restacking operations.



#### Increased Blank Variety

Two types of blanks can be placed on a single loading cart if their size is smaller than 400 x 200mm. This increases the total assortment to 6 positions.

### Robot tablet HMI

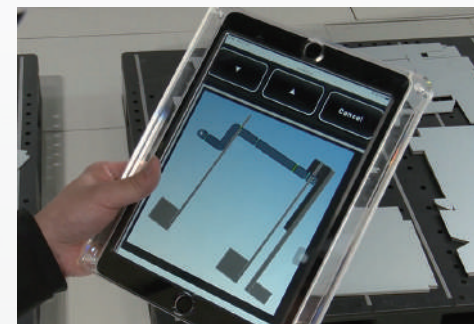

#### Setup support

Portable robot tablet HMI can display setup information and CAM simulation.

\*iPad should be prepared by the customers.

It enables to confirm necessary information anywhere and anytime.

Easy  
Efficiency  
Environmental  
Evolution



\*Minimum flange length may differ depending on bending angles or shapes of die to be used.



## Environmental

Environmentally-friendly

### New servo drive system

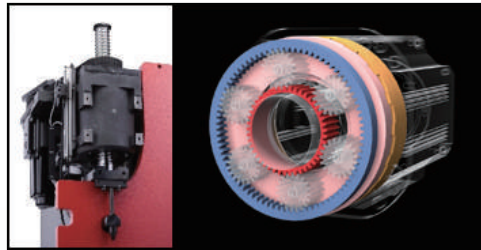

#### High speed & high accuracy

Achieving high speed/low torque and low speed/high torque with a single motor.  
Stable high accuracy is maintained, unaffected by temporal changes in oil temperature.

Max. approach speed 250mm/s  
Max. bending speed 9mm/s  
Max. return speed 250mm/s



#### Reduction of oil volume

Switching from the conventional hydraulic system to the servo motor system has drastically reduced the quantity of hydraulic oil, leading to decreased maintenance costs.

### Idling function



#### Motor-off function reduces power consumption

Equipped with a motion sensor, the NC screen and motors are turned off to reduce power consumption if the robot is idle and there is no operator input for an extended period of time.



## Evolution

Growing together with our customers

Option

### New tool stocker

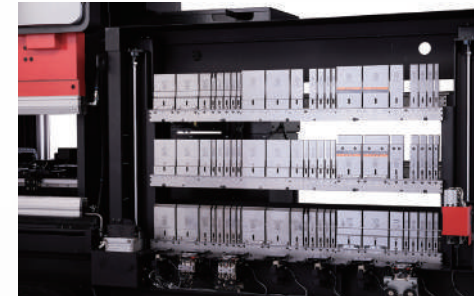

#### Increased loading capacity

The new-type tool stocker increases loading capacity from 20 to 27 types, achieving a smaller footprint through a reassessment of the positional relationship between the machine and the stocker.

### Expanded tool placement area

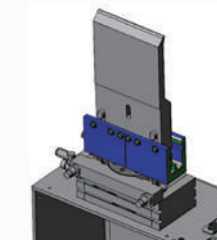
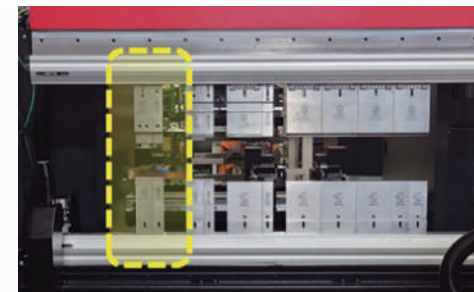

Tool reversing device

The new tool-reversing device expands the tool placement area by eliminating the need for the robot's insertion between tools.

The tool placement area has a front/rear setting of 1160mm.

### New AGC (Automatic Gripper Changer)

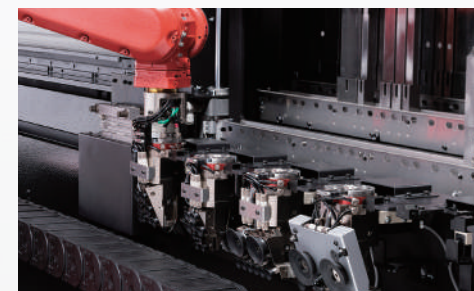

#### Increased gripper loading capacity

The gripper loading capacity has increased from 5 to 8 grippers.

### Active magnet floater ○

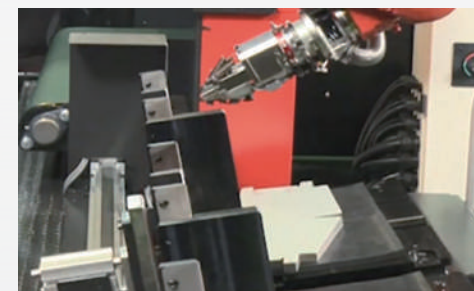

#### Thickness detector

The device prevents the system from picking up two blanks. It ensures stable processing for an extended period by automatically moving to the material position, preventing excessive tilting of the blank due to excessive magnetic force. Additionally, it reduces setup time for the operator.







### Other specifications

○ Option

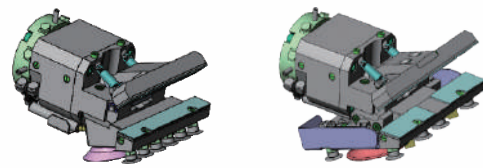

#### Various grippers ○ (some are options)

Various kinds of grippers can be selected depending on customer's products.

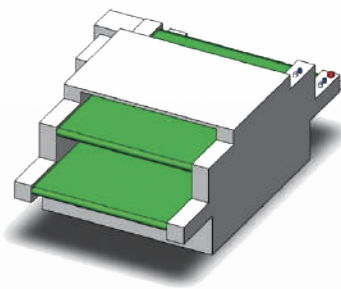

#### Conveyor ○

Can select from 2-stage conveyor (recommended) or 1-stage conveyor in lengths of 2m, 4m and 6m.

### Software

#### VPSS 4ie ARBEND

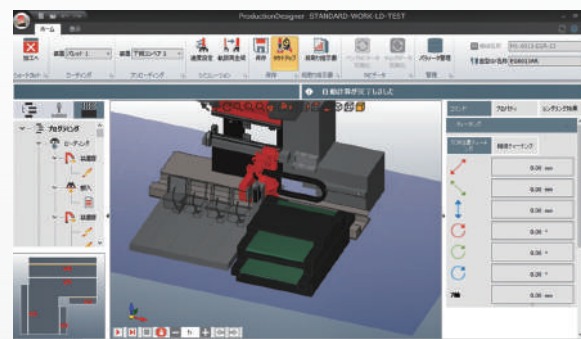

Equipped with the "Programming Assist" function, it generates programming for the bending robot by automatically calculating robot movements, bending steps, tool selections, etc. This enhancement significantly improves usability, making it easy to understand even for beginners, and reduces bending program creation time.

\*BEND CAM is necessary for ARBEND

### Bending robot LINE-UP

\*If the blank mass exceeds the robot's payload capacity, processing may not be possible even if it falls within the specified range.

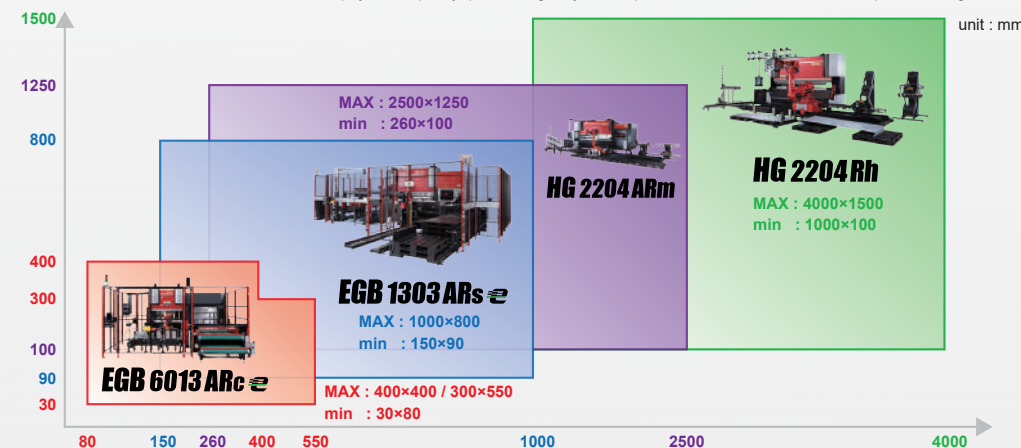

### V-factory

AMADA's recommended V-factory operates on the concept of "creating profits for customers." V-factory collaborates with customers to co-create factory reforms, utilizing IoT technology to visualize operations and maximize machine utilization.

#### V-factory Connecting Box

Used to connect machines to the cloud and start V-factory.

#### V-monitor \*

Automatically records the state of the machine during automatic operation.

